

YDS-KX8-IMX219 V4.0

8MP Sony IMX219 MIPI Interface M12 Fixed Focus Camera Module

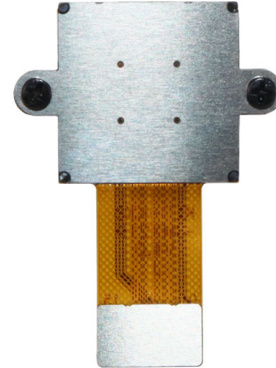

Front View



Back View

Specifications

Camera Module No.	YDS-KX8-IMX219 V4.0
Resolution	8MP
Image Sensor	IMX219
Sensor Type	1/4"
Pixel Size	1.12 um x 1.12 um
EFL	1.65 mm
F.NO	2.00
Pixel	3264 x 2448
View Angle	160.0°(DFOV) 123.0°(HFOV) 91.0°(VFOV)
Lens Dimensions	13.00 x 13.00 x 14.02 mm
Module Size	29.30 x 22.00 mm
Module Type	Fixed Focus
Interface	MIPI
Auto Focus VCM Driver IC	None
Lens Model	YDS-LENS-TRC-4175A2
Lens Type	650nm IR Cut
Operating Temperature	-20°C to +60°C
Mating Connector	DF30FC-30DS-0.4V

YDS-KX8-IMX219 V4.0

8MP Sony IMX219 MIPI Interface M12 Fixed Focus Camera Module



Top View



Side View

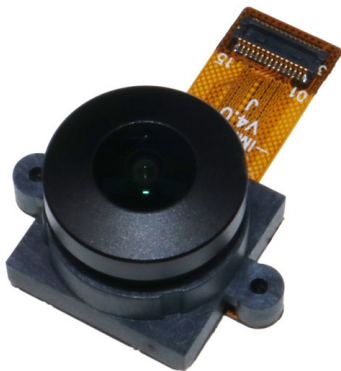

Bottom View

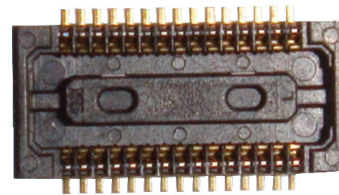

Mating Connector

Real Test Images KX8-IMX219 V4.0

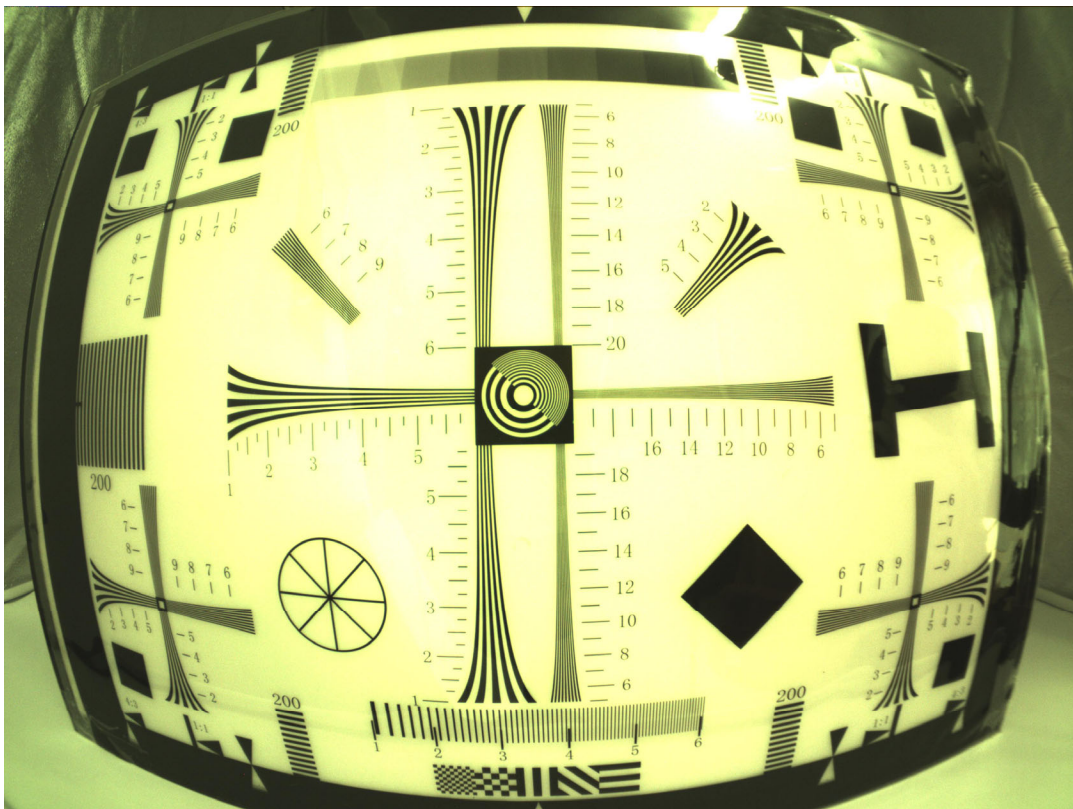

Real Test Images

KX8-IMX219 V4.0

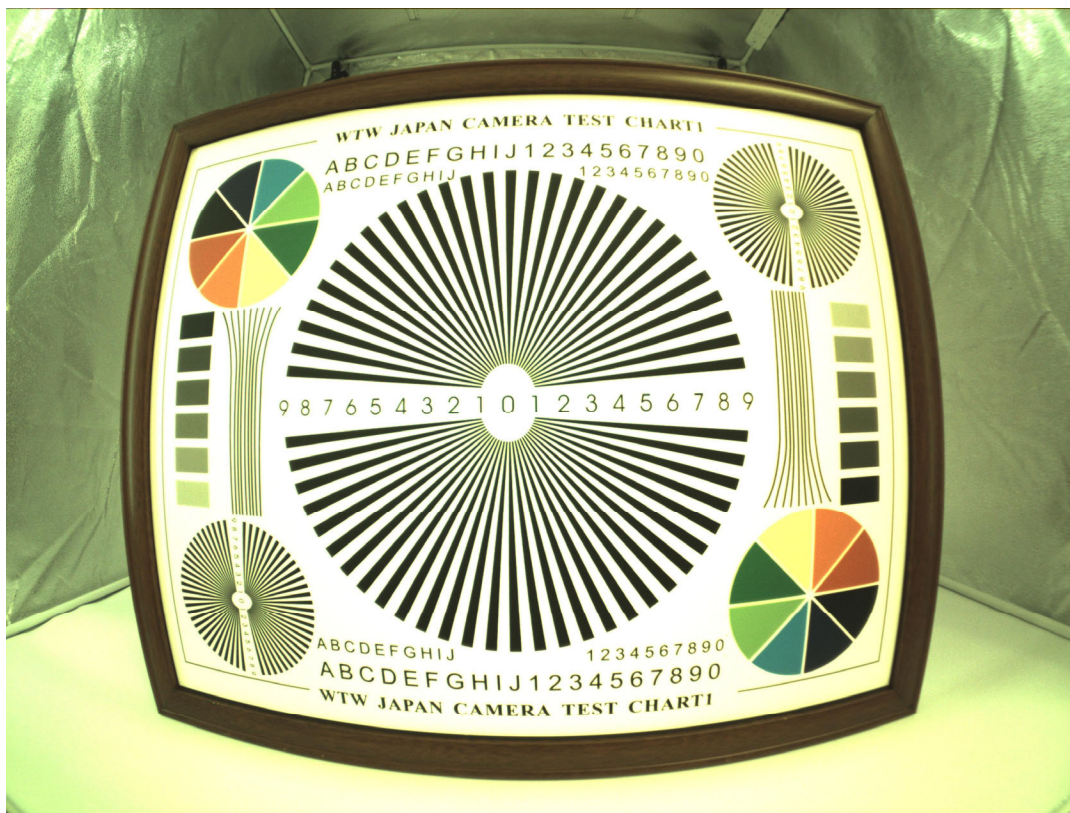

RoHS

1	NC
2	NC
3	DVDD 1.2V
4	D0VDD 1.8V
5	NC
6	AGND
7	AVDD 2.8V
8	DGND
9	I2C-SDA
10	I2C-SCL
11	NC
12	XCLR
13	GND
14	MCLK
15	GND
16	NC
17	NC
18	GND
19	NC
20	NC
21	GND
22	MDP1
23	MDN1
24	GND
25	CLKP
26	CLKN
27	GND
28	MDP0
29	MDN0
30	GND

NOTE:

1. The device slave address: 0x20

Parameter:

1、Sensor specification:

Image Sensor: IMX219

Pixel: 1.12um×1.12um

Lens Type: 1/4

Important Voltage Description: DVDD1.2V (external power supply);

2、Lens specification:

FOV: 160°(D);123°(H);91°(V)

F/NO.: 2.0

TV distortion: <21%

Focal length: 1.65mm

Composition: 2G4P+IR FILTER

IR Cut Coating: 650nm±10nm@50%

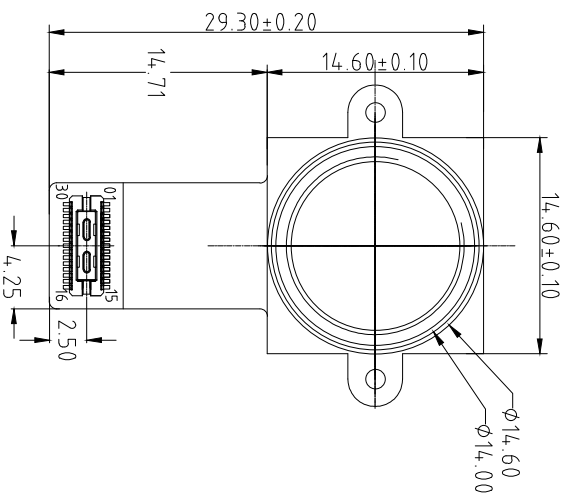
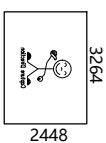

TOP VIEW

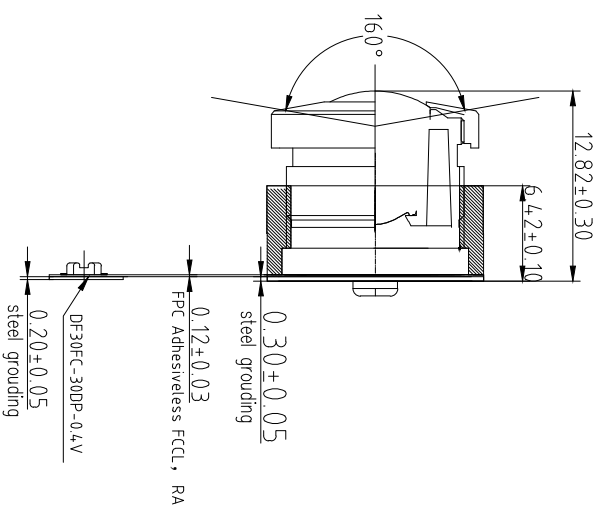

SIDE VIEW

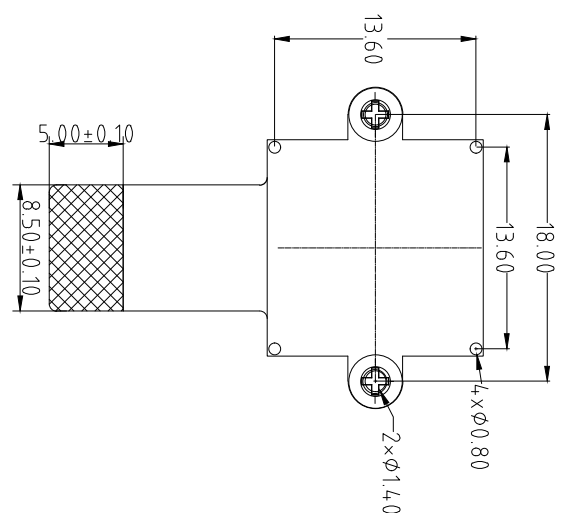

BOTTOM VIEW

Version	Information	Date
V1.0	First Version	08-26-2016
V2.0	Change lens and holder	05-23-2020
V3.0	Shorten FPC length and change connector position	6-3-2021
V4.0	Change lens and holder	3-9-2022

Parameter:

Designed By Kevin

Checked By Aouly_Yan

Model Name: KX8-IMX219 V4.0

Projection Type: Third Angle

Unit: mm

Scale: 1:1

Material: -----

Sheet: 1 of 1

Version: 1/0

Version: 1/0

Sheet: 1 of 1

Material: -----

Scale: 1:1

Projection Type: Third Angle

Model Name: KX8-IMX219 V4.0

3

3

3

3

3

3

2

2

2

2

2

2

1

1

1

1

1

1

[Product Brief]

Ver.1.0

IMX219PQ

Diagonal 4.60mm (Type 1/4.0) 8M Pixel CMOS Image Sensor with Square Pixel for Color Cameras

Description

IMX219PQ is a diagonal 4.60mm (Type 1/4.0) CMOS active pixel type image sensor with a square pixel array and 8.08M effective pixels. This chip operates with three power supplies, analogue 2.8V, digital 1.2 V, and IF 1.8 V, and has low power consumption. High sensitivity, low dark current, and no smear are achieved through the adoption of R, G, and B primary color pigment mosaic filters. This chip features an electronic shutter with variable charge-storage time.

In addition, this product is designed for use in cellular phone and tablet pc. When using this for another application, Sony does not guarantee the quality and reliability of product. Therefore, don't use this for applications other than cellular phone and tablet pc. Consult your Sony sales representative if you have any questions.

Functions and Features

- ◆ Back-illuminated CMOS image sensor Exmor R™
- ◆ 2-wire serial communication circuit on chip
- ◆ CSI2 serial data output (selection of 4lane/2lane)
- ◆ Timing generator, H and V driver circuits on chip
- ◆ CDS/PGA on chip
- ◆ 10-bit A/D converter on chip
- ◆ Automatic optical black (OB) clamp circuit on chip
- ◆ PLL on chip (rectangular wave)
- ◆ High sensitivity, low dark current, no smear
- ◆ Excellent anti-blooming characteristics
- ◆ Variable-speed shutter function (1 H units)
- ◆ R, G, B primary color pigment mosaic filters on chip
- ◆ Max. 30frame/s in all-pixel scan mode
- ◆ Pixel rate: 280 [Mpixel/s] (All-pixels mode)
- ◆ 180 frame/s @720p with 2x2 analog (special) binning, 60 frame/s @1080p with V-crop
- ◆ Datarate: Max.755Mbps/lane (@4lane), 912Mbps/Lane(@2lane)

Device Structure

- ◆ CMOS image sensor
- ◆ Image size : Diagonal 4.60mm (Type 1/4.0)
- ◆ Total number of pixels : 3296(H) × 2512(V) approx. 8.28M pixels
- ◆ Number of effective pixels : 3296(H) × 2480(V) approx. 8.17M pixels
- ◆ Number of active pixels : 3280(H) × 2464(V) approx. 8.08M pixels
- ◆ Chip size : 5.095mm (H) × 4.930mm (V) (w/ Scribe)
- ◆ Unit cell size : 1.12μm (H) × 1.12μm (V)
- ◆ Substrate material : Silicon

Functional Description

Block diagram

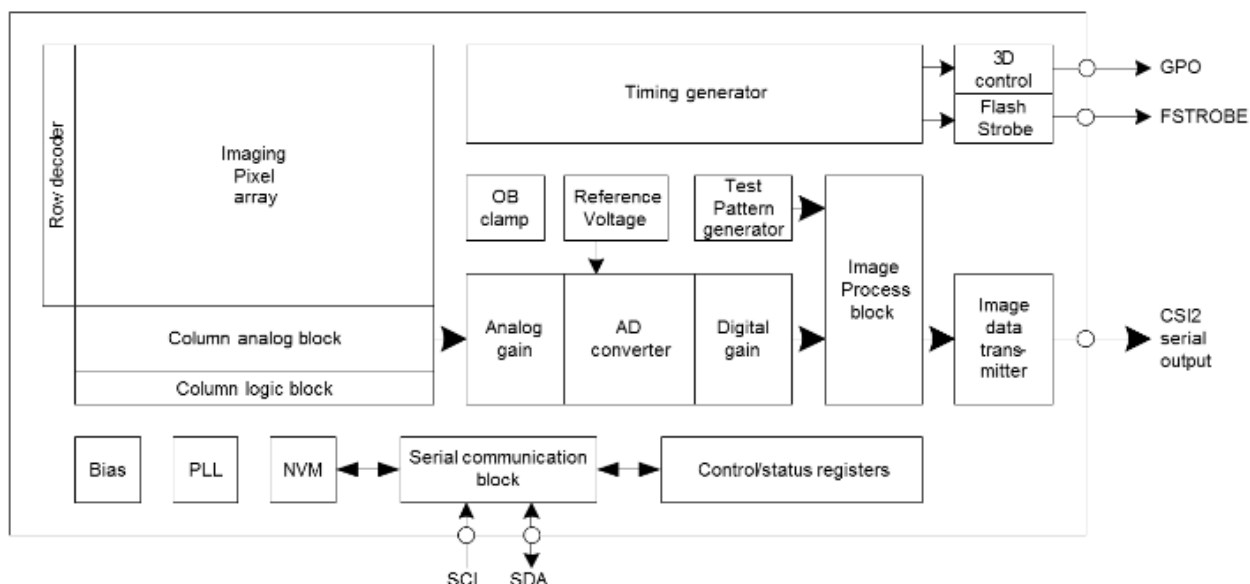

Exmor R

* Exmor R is a trademark of Sony Corporation. The Exmor R is a Sony's CMOS image sensor with significantly enhanced imaging characteristics including sensitivity and low noise by changing fundamental structure of Exmor™ pixel adopted column parallel A/D converter to back-illuminated type.

Sony reserves the right to change products and specifications without prior notice.

This information does not convey any license by any implication or otherwise under any patents or other right.

Application circuits shown, if any, are typical examples illustrating the operation of the devices. Sony cannot assume responsibility for any problems arising out of the use of these circuits.

YDS-LENS-TRC-4175A2

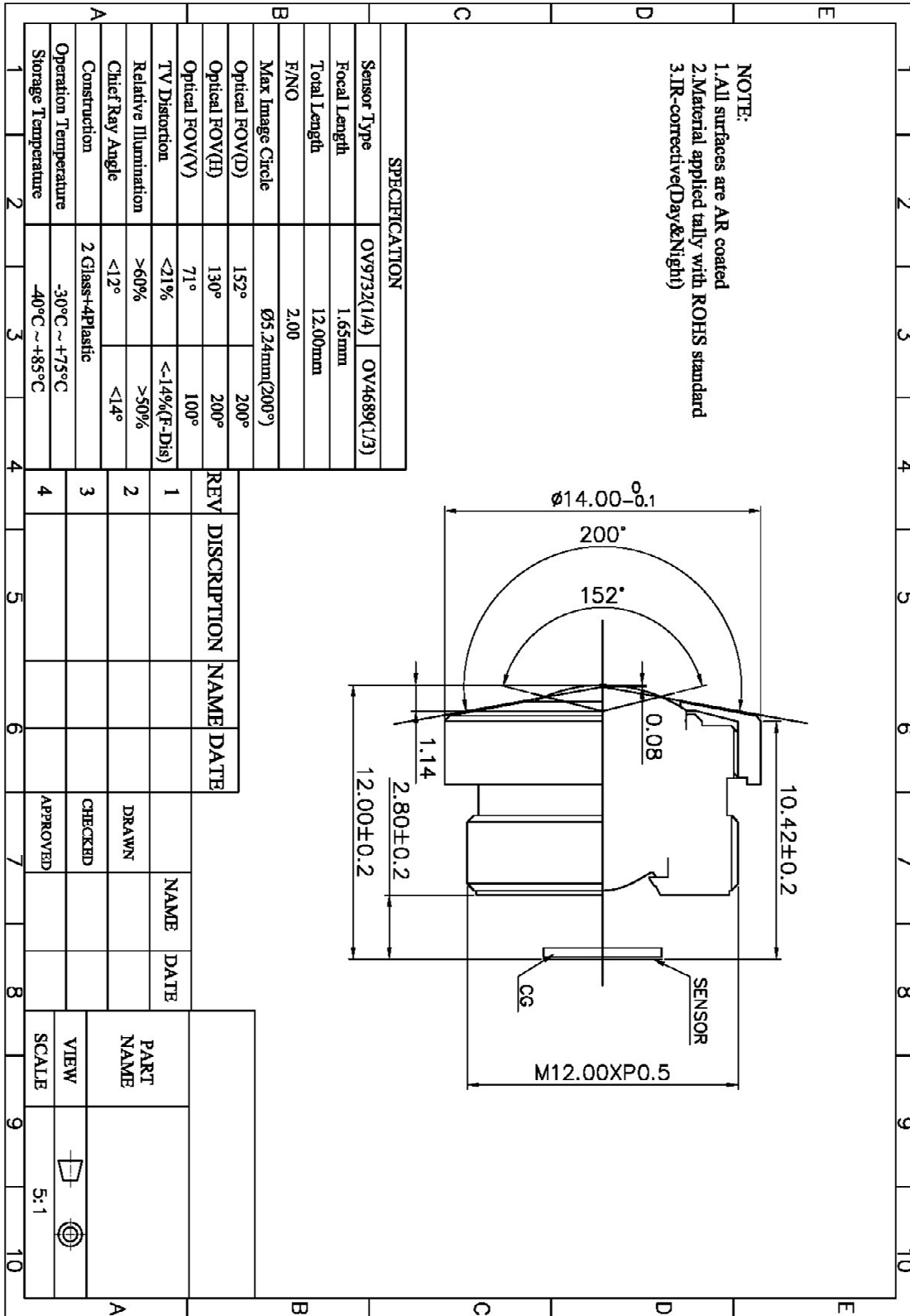

0.4 mm Pitch, 0.9 mm Height, Board-to-Board / Board-to-FPC Connectors

DF30 Series

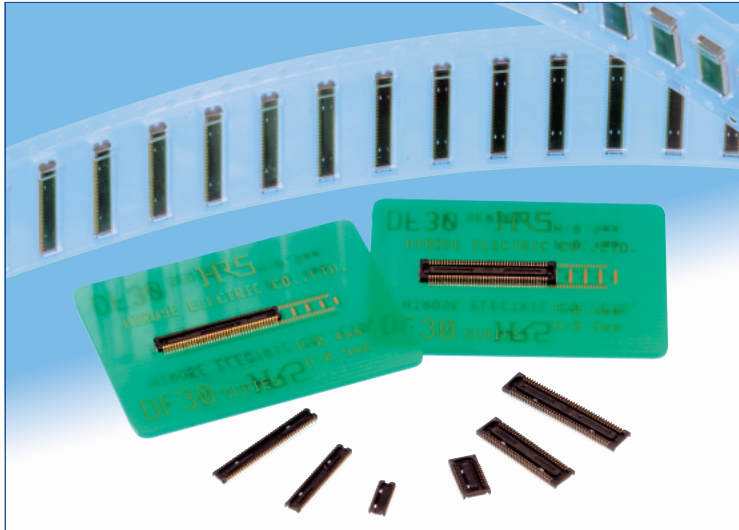

Extremely small size

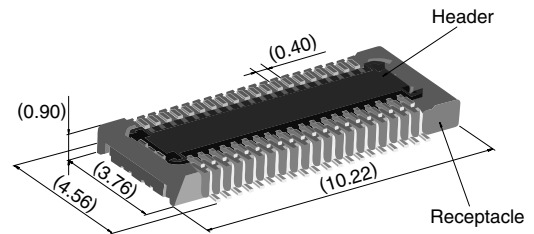

40 positions shown

Overview

Continuous miniaturization and increased component density on PCB created demand for extremely low profile connectors. This series is addition of a new extremely low profile connectors to Hirose's wide range of high reliability board-to-board/board-to-FPC connection solutions.

Features

1. Contact reliability

Concentration of the contact's normal forces at the single point assures good contact wipe and electrical reliability, while confirming the fully mated condition with a definite tactile click.

2. Self alignment

Recognizing the difficulties of mating extremely small connectors in limited spaces the connectors will self align in horizontal axis within 0.3 mm.

3. Automatic board placement

Packaged on tape-and-reel the plug and headers have sufficiently large flat areas to allow pick-up with vacuum nozzles of automatic placement equipment.

4. Variety of contact positions and styles

Available in standard contact positions of: 20, 22, 24, 30, 34, 40, 50, 60, 70 and 80 with and without metal fittings. Addition of metal fittings does not affect external dimensions of the connectors.

Smaller contact positions are also available.

5. Support for continuity test connector

Connectors which have increased insertion and removal durability are available for continuity tests. Contact your Hirose sales representative for details.

Applications

Cellular phones, PDA's, mobile computers, digital cameras, digital video cameras, and other devices demanding high reliability connections in extremely limited spaces.

Low profile

Increased mated retention

High contact reliability

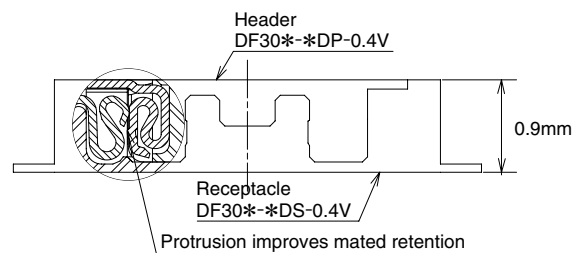

Self alignment

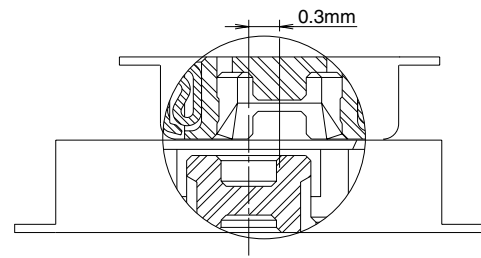

Product Specifications

Rating	Rated current 0.3A Rated voltage 30V AC	Operating temperature range : -35°C to 85°C (Note 1) Operating humidity range : Relative humidity 20% to 80%	Storage temperature range -10°C to 60°C (Note 2) Storage humidity range Relative humidity 40% to 70% (Note 2)
--------	--	---	--

Item	Specification	Conditions
1. Insulation resistance	50 MΩ min.	100V DC
2. Withstanding voltage	No flashover or insulation breakdown.	100V AC / one minute
3. Contact resistance	100 mΩ max.	100 mA
4. Vibration	No electrical discontinuity of 1 μs or more	Frequency: 10 to 55 Hz, single amplitude of 0.75mm, 2 hours, 3 axis
5. Humidity	Contact resistance: 100 mΩ max. Insulation resistance: 25 MΩ min.	96 hours at temperature of 40°C±2°C and RH of 90% to 95%
6. Temperature cycle	Contact resistance: 100 mΩ max. Insulation resistance: 50 MΩ min.	Temperature: -55°C→+5°C to +35°C→+85°C→+5°C to +35°C Duration: 30→10→30→10(Minutes) 5 cycles
7. Durability (insertions/withdrawals)	Contact resistance: 100 mΩ max.	50 cycles(Connector for conductivity tests: 500 cycles)
8. Resistance to soldering heat	No deformation of components affecting performance.	Reflow: At the recommended temperature profile Manual soldering: 300°C for 3 seconds

Note 1: Includes temperature rise caused by current flow.

Note 2: The term "storage" refers to products stored for long period of time prior to mounting and use. Operating temperature range and humidity range covers non-conducting condition of installed connectors in storage, shipment or during transportation.

Materials and Finishes

Connectors	Component	Material	Finish	Remarks
Receptacles and Headers	Insulator	LCP	Color : Black	UL94V-0
	Contacts	Phosphor bronze	Gold plated	————
	Metal fittings	Phosphor bronze	Tin-copper plated	————

Ordering information

Receptacles and Headers

DF30 **FC -** ***** **DS - 0.4** **V** **(**)**
 ① ② ③ ④ ⑤ ⑥ ⑦

① Series name: DF30	⑤ Contact pitch: 0.4 mm
② Configuration FB: With metal fittings, without bosses FC: Without metal fittings, without bosses CJ: Connector for conductivity tests	⑥ Termination section V: Straight SMT
③ Number of positions: 20, 22, 24, 30, 34, 40, 50, 60, 70, 80	⑦ Packaging (81): Embossed tape packaging (5,000 pieces per reel) (82): Embossed tape packaging (1,000 pieces per reel)
④ Connector type DS: Double row receptacle DP: Double row header	

■ Receptacles (without metal fittings)

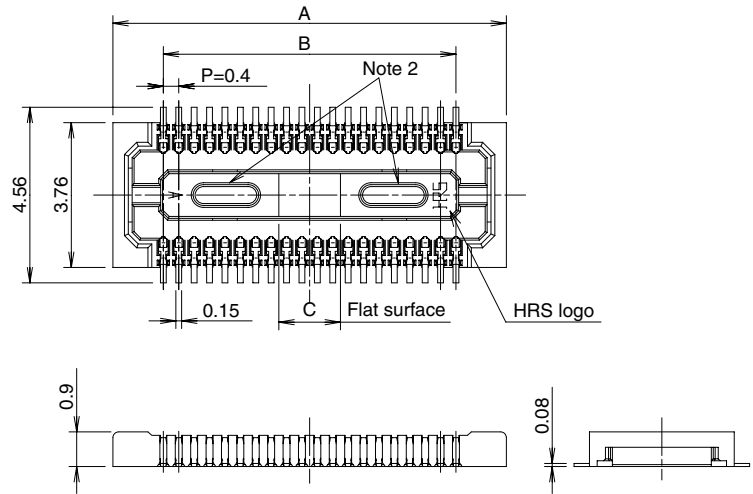
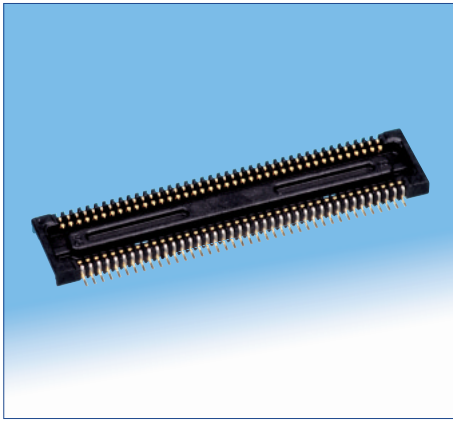

◆ Recommended PCB mounting pattern

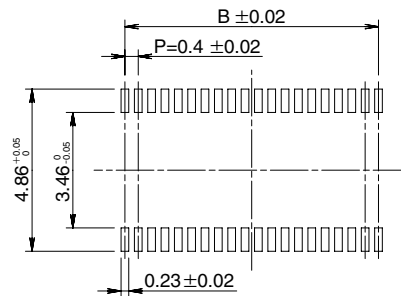

Recommended solder paste thickness: 120 μm

[Specification number] -**, (**)
(81): Embossed tape packaging (5,000 pieces per reel)

* Tolerances non- accumulative.

Unit: mm

Part Number	CL No.	Number of contacts	A	B	C
DF30FC-20DS-0.4V(**)	CL684-1109-8-**	20	6.22	3.6	1.2
DF30FC-22DS-0.4V(**)	CL684-1110-7-**	22	6.62	4.0	1.2
DF30FC-24DS-0.4V(**)	CL684-1111-0-**	24	7.02	4.4	1.2
DF30FC-30DS-0.4V(**)	CL684-1112-2-**	30	8.22	5.6	1.2
DF30FC-34DS-0.4V(**)	CL684-1113-5-**	34	9.02	6.4	1.36
DF30FC-40DS-0.4V(**)	CL684-1078-6-**	40	10.22	7.6	1.6
DF30FC-50DS-0.4V(**)	CL684-1114-8-**	50	12.22	9.6	2.0
DF30FC-60DS-0.4V(**)	CL684-1082-3-**	60	14.22	11.6	2.4
DF30FC-70DS-0.4V(**)	CL684-1115-0-**	70	16.22	13.6	2.8
DF30FC-80DS-0.4V(**)	CL684-1116-3-**	80	18.22	15.6	3.2

Note 1: Order by number of reels.

Note 2: Receptacles with 24 or fewer contacts positions will not have recessed areas.



YDS CAMERA MODULE

your best camera partner

Camera Module Pinout Definition Reference Chart

OmniVision	Sony	Samsung	On-Semi	Aptina	Himax	GalaxyCore	PixArt	SmartSens	Sensors
Pin Signal		Description							
DGND	GND	ground for digital circuit							
AGND		ground for analog circuit							
PCLK	DCK	DVP PCLK output							
XCLR	PWDN	XSHUTDOWN	STANDBY	power down active high with internal pull-down resistor					
MCLK	XVCLK	XCLK	INCK	system input clock					
RESET	RST	reset active low with internal pull-up resistor							
NC	NULL	no connect							
SDA	SIO_D	SIOD	SCCB data						
SCL	SIO_C	SIOC	SCCB input clock						
VSYNC	XVS	FSYNC	DVP VSYNC output						
HREF	XHS	DVP HREF output							
DOVDD	power for I/O circuit								
AFVDD	power for VCM circuit								
AVDD	power for analog circuit								
DVDD	power for digital circuit								
STROBE	FSTROBE	strobe output							
FSIN	synchronize the VSYNC signal from the other sensor								
SID	SCCB last bit ID input								
ILPWM	mechanical shutter output indicator								
FREX	frame exposure / mechanical shutter								
GPIO	general purpose inputs								
SLASEL	I2C slave address select								
AFEN	CEN chip enable active high on VCM driver IC								
MIPI Interface									
MDN0	DN0	MD0N	DATA_N	DMO1N	MIPI 1st data lane negative output				
MDP0	DP0	MD0P	DATA_P	DMO1P	MIPI 1st data lane positive output				
MDN1	DN1	MD1N	DATA2_N	DMO2N	MIPI 2nd data lane negative output				
MDP1	DP1	MD1P	DATA2_P	DMO2P	MIPI 2nd data lane positive output				
MDN2	DN2	MD2N	DATA3_N	DMO3N	MIPI 3rd data lane negative output				
MDP2	DP2	MD2P	DATA3_P	DMO3P	MIPI 3rd data lane positive output				
MDN3	DN3	MD3N	DATA4_N	DMO4N	MIPI 4th data lane negative output				
MDP3	DP3	MD3P	DATA4_P	DMO4P	MIPI 4th data lane positive output				
MCN	CLKN	CLK_N	DCKN	MIPI clock negative output					
MCP	CLKP	MCP	CLK_P	DCKN	MIPI clock positive output				
DVP Parallel Interface									
D0	DO0	Y0	DVP data output port 0						
D1	DO1	Y1	DVP data output port 1						
D2	DO2	Y2	DVP data output port 2						
D3	DO3	Y3	DVP data output port 3						
D4	DO4	Y4	DVP data output port 4						
D5	DO5	Y5	DVP data output port 5						
D6	DO6	Y6	DVP data output port 6						
D7	DO7	Y7	DVP data output port 7						
D8	DO8	Y8	DVP data output port 8						
D9	DO9	Y9	DVP data output port 9						
D10	DO10	Y10	DVP data output port 10						
D11	DO11	Y11	DVP data output port 11						

www.YDSCAM.com sales@ydscam.com Phone (WeChat, QQ): (+86) 177 2732 6718

All rights reserved @ YingDeShun Co. Ltd. Specifications subject to change without notice.

Cameras Applications



IMAGING DEVICES



Camera Reliability Test

Reliability Inspection Item		Testing Method	Acceptance Criteria	
Category	Item			
Environmental	Storage Temperature	High 60°C 96 Hours	Temperature Chamber	No Abnormal Situation
		Low -20°C 96 Hours	Temperature Chamber	No Abnormal Situation
	Operation Temperature	High 60°C 24 Hours	Temperature Chamber	No Abnormal Situation
		Low -20°C 24 Hours	Temperature Chamber	No Abnormal Situation
	Humidity	60°C 80% 24 Hours	Temperature Chamber	No Abnormal Situation
	Thermal Shock	High 60°C 0.5 Hours Low -20°C 0.5 Hours Cycling in 24 Hours	Temperature Chamber	No Abnormal Situation
Physical	Drop Test (Free Falling)	Without Package 60cm	10 Times on Wood Floor	Electrically Functional
		With Package 60cm	10 Times on Wood Floor	Electrically Functional
	Vibration Test	50Hz X-Axis 2mm 30min	Vibration Table	Electrically Functional
		50Hz Y-Axis 2mm 30min	Vibration Table	Electrically Functional
		50Hz Z-Axis 2mm 30min	Vibration Table	Electrically Functional
	Cable Tensile Strength Test	Loading Weight 4 kg 60 Seconds Cycling in 24 Hours	Tensile Testing Machine	Electrically Functional
Electrical	ESD Test	Contact Discharge 2 KV	ESD Testing Machine	Electrically Functional
		Air Discharge 4 KV	ESD Testing Machine	Electrically Functional
	Aging Test	On/Off 30 Seconds Cycling in 24 Hours	Power Switch	Electrically Functional
	USB Connector	On/Off 250 Times	Plug and Unplug	Electrically Functional



Camera Inspection Standard

Inspection Item		Inspection Method	Standard of Inspection		
Category	Item				
Appearance	FPC/ PCB	Color	The Naked Eye	Major Difference is Not Allowed.	
		Be Torn/Chopped	The Naked Eye	Copper Crack Exposure is Not Allowed.	
		Marking	The Naked Eye	Clear, Recognizable (Within 30cm Distance)	
	Holder	Scratches	The Naked Eye	The Inside Crack Exposure is Not Allowed	
		Gap	The Naked Eye	Meet the Height Standard	
		Screw	The Naked Eye	Make Sure Screws Are Presented (If Any)	
		Damage	The Naked Eye	The Inside Crack Exposure is Not Allowed	
	Lens	Scratch	The Naked Eye	No Effect On Resolution Standard	
		Contamination	The Naked Eye	No Effect On Resolution Standard	
		Oil Film	The Naked Eye	No Effect On Resolution Standard	
		Cover Tape	The Naked Eye	No Issue On Appearance.	
	Function	Image	No Communication	Test Board	Not Allowed
			Bright Pixel	Black Board	Not Allowed In the Image Center
Dark Pixel			White board	Not Allowed In the Image Center	
Blurry			The Naked Eye	Not Allowed	
No Image			The Naked Eye	Not Allowed	
Vertical Line			The Naked Eye	Not Allowed	
Horizontal Line			The Naked Eye	Not Allowed	
Light Leakage			The Naked Eye	Not Allowed	
Blinking Image			The Naked Eye	Not Allowed	
Bruise			Inspection Jig	Not Allowed	
Resolution			Chart	Follows Outgoing Inspection Chart Standard	
Color			The Naked Eye	No Issue	
Noise			The Naked Eye	Not Allowed	
Corner Dark			The Naked Eye	Less Than 100px By 100px	
Color Resolution			The Naked Eye	No Issue	
Dimension	Height	The Naked Eye	Follows Approval Data Sheet		
	Width	The Naked Eye	Follows Approval Data Sheet		
	Length	The Naked Eye	Follows Approval Data Sheet		
	Overall	The Naked Eye	Follows Approval Data Sheet		

YDSCAM Package Solutions

YDS Camera Module



Complete with Lens Protection Film



Tray with Grid and Space



Place Cameras on the Tray

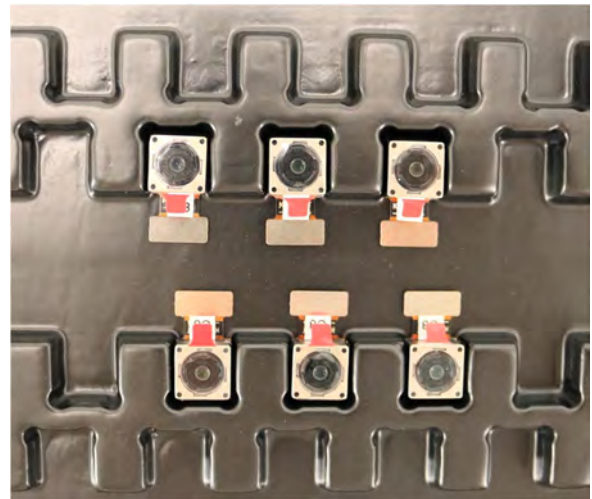

YDSCAM Package Solutions

Full Tray of Cameras

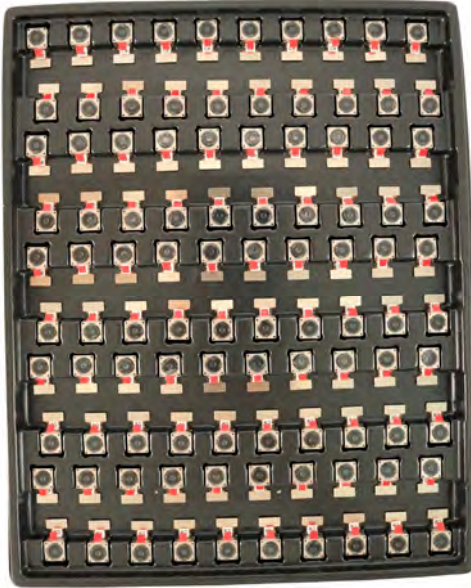

Cover Tray with Lid

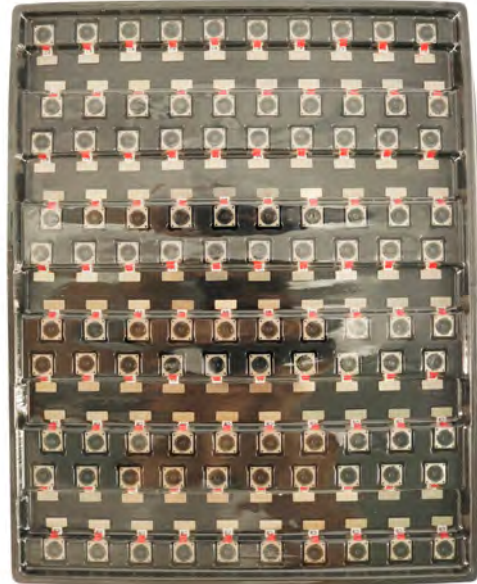

Place Tray into Anti-Static Bag



Vacuum the Anti-Static Bag



YDSCAM Package Solutions

Sealed Vacuum Anti-Static Bag with Labels

1. Model and Description 2. Quantity 3. Manufacturing Date Code 4. Caution



YDSCAM Package Solutions

Place Foam Sheets Between Tray Bags



Foam Sheets are Larger Than Trays



Place Foam Sheets and Trays into Box



Foam Sheets are Tightly Fitting in Box



Seal the Carbon Box



Label the Carbon Shipping Box





YDSCAM Package Solutions

USB Camera Module

Complete with Lens Protection Film

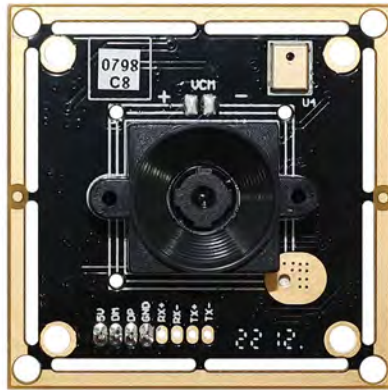

Place Camera Sample into Anti-Static Bag

Place USB Cameras into Tray



Seal the Tray with Anti-Static Bag

Label the Carbon Shipping Box



YDSCAM Package Solutions

Place Camera Sample into Anti-Static Bag



Place Connectors into Anti-Static Bag



Label the Sample Bags



Place Connectors into Reel



Place Samples into the Carbon Box



Place Connectors into the Carbon Box





YDS CAMERA MODULE

your best camera partner

Company YDSCAM

YingDeShun Co. Ltd. (YDS) was established in 2017, a next-generation technology driven manufacturer specialized in research, design, and produce of audio and video products. YDS is occupying 20,000 square feet automated plants with 100 employees of annual throughput 30,000,000 units cameras.

YDS provides OEM, ODM design, contract manufacturing, and builds the camera products. You may provide the requirements to us, even with a hand draft, our sales and engineering work together to meet your needs. We consider ourselves your last-term partner in developing practical and innovative solutions.

Our team covers everything from initial concept development to mass produced product. YDS specializes in customized camera design, raw material, electronic engineering, firmware/software development, product testing, and packing design. Our experienced strategic supply systems offer a robust and dependable manufacturing capacity for orders of various sizes.

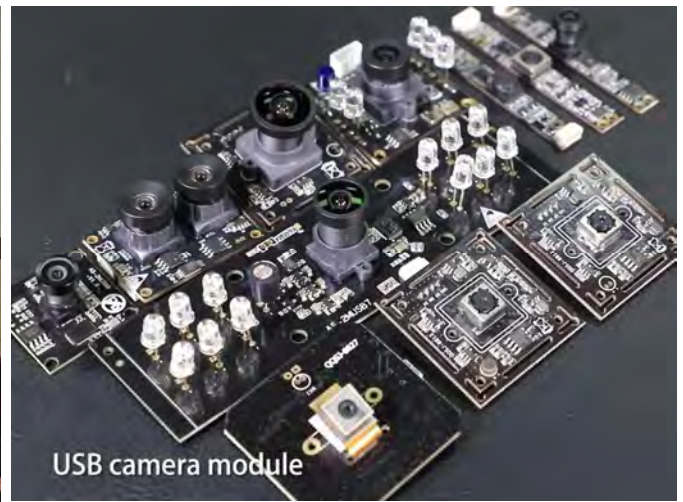

Limited Warranty

YDS provides the following limited warranty if you purchased the Product(s) directly from YDS company or from YDS's website www.YDSCAM.com. Product(s) purchased from other sellers or sources are not covered by this Limited Warranty. YDS guarantees that the Product(s) will be free from defects in materials and workmanship under normal use for a period of one (1) year from the date you receive the product ("Warranty Period").

For all Product(s) that contain or develop material defects in materials or workmanship during the Warranty Period, YDS will, at its sole option, either: (i) repair the Product(s); (ii) replace the Product(s) with a new or refurbished Product(s) (replacement Product(s) being of identical model or functional equivalent); or (iii) provide you a refund of the price you paid for the Product(s).

This Limited Warranty of YDS is solely limited to repair and/or replacement on the terms set forth above. YDS is not reliable or responsible for any subsequent events.



www.YDSCAM.com sales@ydscom.com Phone (WeChat, QQ): (+86) 177 2732 6718

All rights reserved @ YingDeShun Co. Ltd. Specifications subject to change without notice.



YDS CAMERA MODULE

your best camera partner

YDS Strength

Powerful Factory



Professional Service



Promised Delivery



www.YDSCAM.com sales@ydscam.com Phone (WeChat, QQ): (+86) 177 2732 6718

All rights reserved @ YingDeShun Co. Ltd. Specifications subject to change without notice.